



User Guide

Precision Balance MPB410





Contents

1.0 INTRODUCTION	4
2.0 TECHNICAL SPECIFICATIONS.....	5
3.0 UNPACKING THE BALANCE.....	6
4.0 LOCATING THE BALANCE.....	7
5.0 SETTING UP THE BALANCE	8
5.1 ASSEMBLING THE BALANCE.....	8
5.2 LEVELLING THE BALANCE	9
5.3 WARM-UP TIME.....	9
6.0 DISPLAY.....	10
7.0 KEYPAD	12
7.1 NUMERIC ENTRY METHOD	12
8.0 INPUT/OUTPUT	13
9.0 OPERATIONS	14
9.1 INITIALISATION	14
9.2 PASSCODES	14
9.3 WEIGHING	15
9.3.1 Weighing Units.....	15
9.4 FUNCTIONS.....	16
9.4.1 Parts Counting.....	16
9.4.2 Percent Weighing.....	17
9.4.3 Check Weighing.....	18
10.0 CALIBRATION.....	20
11.0 RS-232 INTERFACE	21
12.0 ERROR CHECKING	25
13.0 SUPERVISOR MENUS	26



13.1 ENABLE WEIGHING UNITS	26
13.2 ENABLE WEIGHING MODES	26
13.3 ENABLE SERIAL INTERFACE PARAMETERS	27
13.4 SETUP PARAMETERS	29
13.5 CALIBRATION SETUP	30
13.6 PASSCODES	31
13.6.1 Forgotten Passcodes	31
14.0 SAFETY AND MAINTENANCE	32
15.0 TROUBLE-SHOOTING.....	32
16.0 BALANCE MENU STRUCTURE.....	36
Manufacturer's Declaration of Conformity.....	39



1.0 INTRODUCTION

Thank you for selecting the Precision Balance.

This Instruction Manual will familiarise you with the installation, troubleshooting, general maintenance of the balance, etc. and will guide you through the various applications.

Please read this Manual thoroughly before starting the operation. If you need any clarifications, feel free to contact your supplier.

PRODUCT OVERVIEW

This Precision Balance is ideal for laboratory and general purpose weighing.

FEATURES:

- Large easy to read LCD display with backlight
- Applications include weighing, parts counting, check weighing and percentage weighing
- External calibration
- Bi-directional RS-232 interface
- Can be configured to print a GLP Compliant report after each calibration to include the time, date, balance number and a verification of the calibration
- Automatic temperature compensation
- Display in 4 languages- English, French, German and Spanish
- Multiple weighing units
- Date and time
- Easy to use, sealed keypad
- Below balance weighing facility
- Password protection
- Security locking point
- Robust metal casing



2.0 TECHNICAL SPECIFICATIONS

	MPB410
Maximum capacity	410g
Readability	0.001g
Typical Repeatability	0.002g
Linearity (\pm)	0.002g
Tare range	Full
Units of measure	grams, milligrams, kilograms, carats, pennyweights, grains, troy ounce, ounces
Interface	RS-232 bi-directional
Operating temperature	10°C - 40°C
Power supply	12 VDC, 50/60 Hz, 800 mA
Calibration	External (Selectable automatic calibration due to change in time or temperature)
Suggested calibration weight	200g
Display	Backlit LCD with dual digits (24 mm high)
Draught shield	Standard for 0.001g units
Housing	Die cast aluminium housing With glass draught shield
Pan size	125 mm x 145mm / 4.9" x 5.7"
Overall dimensions (w x d x h)	251 x 358 x 178 9.9"x 14.1" x 7" with breeze shield fitted
Net weight	5.5 kg / 12 lb
Applications	Weighing, Parts counting, Percentage weighing, Check weighing



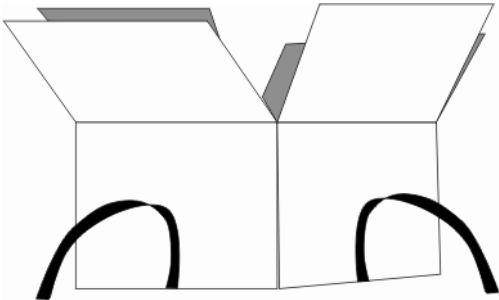

3.0 UNPACKING THE BALANCE

Remove the balance from the packing by carefully lifting it out of the box. Inside the box you will find everything needed to start using the balance.



- ✓ AC adapter
- ✓ Plastic sub-pan
- ✓ Stainless Steel Top Pan
- ✓ Breeze / draught shield (For 0.001g models)
- ✓ This User Manual

4.0 LOCATING THE BALANCE

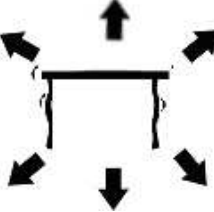
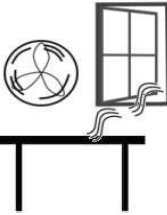
	<ul style="list-style-type: none"> • The balance should not be placed in a location that will reduce the accuracy. • Avoid extremes of temperature. Do not place in direct sunlight or near air conditioning vents.
	<ul style="list-style-type: none"> • Avoid unsuitable tables. The table or floor must be rigid and not vibrate.
	<ul style="list-style-type: none"> • Avoid unstable power sources. Do not use near large users of electricity such as welding equipment or large motors. • Do not place near vibrating machinery. • Avoid high humidity that might cause condensation. Avoid direct contact with water. Do not spray or immerse the balances in water.
	<ul style="list-style-type: none"> • Avoid air movement such as from fans or opening doors. Do not place near open windows or air-conditioning vents. • Keep the balance clean. Do not stack material on the balances when they are not in use.

5.0 SETTING UP THE BALANCE

5.1 ASSEMBLING THE BALANCE

- Locate the balance on a solid surface, free from vibration
- For the low capacity scales (0.001g) remove the shipping protection screw and transit disc from the top of the balance and place the plastic top pan support on the balance. Do not use excessive force when removing and installing the screw.

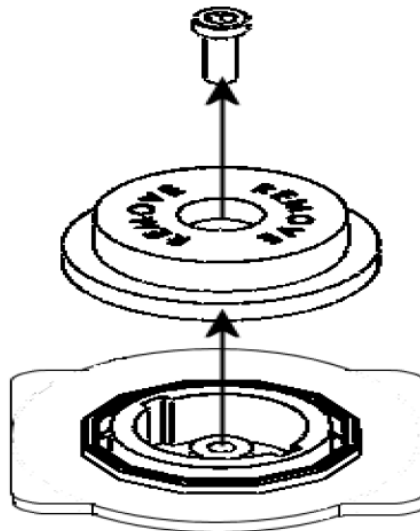

- Gently place the plastic pan support into the receptacle and secure with the supplied screw. Do not over-tighten the screw. It should be finger tight only. Put the Stainless steel pan on top of the pan support
- NOTE: The plastic pan support can be fitted in 2 orientations, place it in the orientation that has the smallest gap between the front edge and the display.
- Place the draught shield frame and the top cover around the pan (for 0.001g models only).
- Level the balance using the adjustable feet and spirit level.
- Connect power to the balance.



- For best performance, let the balance warm up for 15 minutes and calibrate before using.

5.2 LEVELLING THE BALANCE

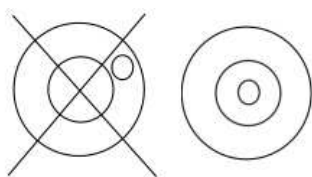

After placing the balance in a suitable place, level it by using the spirit level on the rear of the balance. To level the balance turn the two adjustable feet at the rear of the balance until the bubble in the spirit level is centered.

5.3 WARM-UP TIME

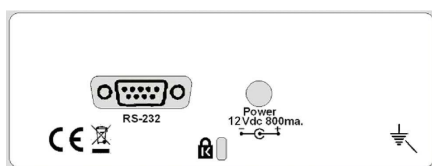

Attach the power supply cable to the connector on the rear of the balance. Plug the power supply module into the mains. The display will indicate the balance serial number (if set) and the software revision number followed by the capacity of the balance.

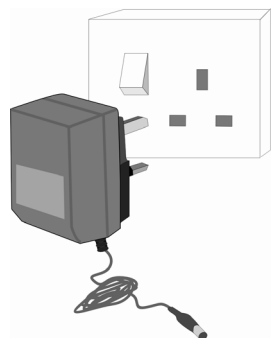

Next the balance will run a self-test by displaying all segments and then will show zeroes accompanied by the zero symbol. If the balance serial number is not set, the display will show dashes.

Before you start weighing, you have to wait for the balance to achieve a stable internal temperature. Typical initial warm-up time suggested for a balance already at room temperature is about 15 minutes.



A stable sign ~ is shown when the balance is instable condition. It will turn off if the balance is not stable. Exact zero is shown when the “→0←” symbol is on to the left of the display area.

6.0 DISPLAY

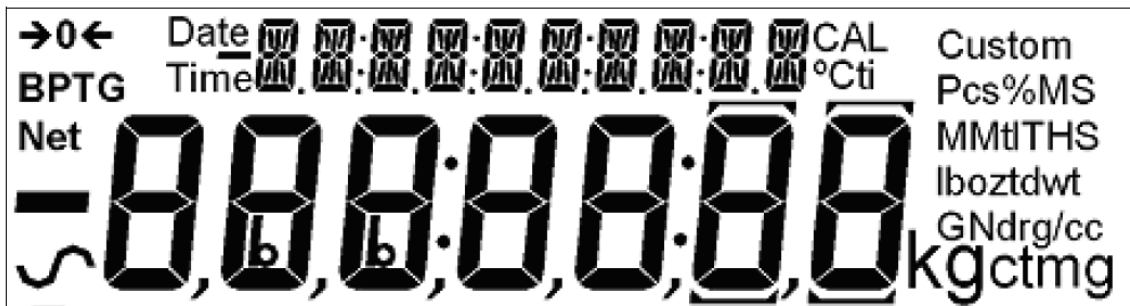

The LCD has several areas-

- A large 7 digit area to display the weight with symbols for common weighing units on its right and symbols for zero, tare (Net) and stability on the left.
- A 10 digit area which allows a large amount of flexibility for displaying text messages concerning menus, operation and errors, for example to display the current weighing mode or to guide the user through processes such as density determination.



SYMBOLS AND INDICATORS





The LCD has unique symbols to indicate the following:

0←	Zero
	Stable
g, oz, ozt, GN, dwt, ct, Kg, mg, Pcs, %	Text is shown for the weighing units and modes
“CAL”	When calibration is occurring or about to occur
“°C”	When a temperature is shown or a calibration is requested due to change in temperature
“ti”	For a time driven calibration
“Net”	When a net weight is shown



7.0 KEYPAD

The keypad has the following keys to operate the balance.

Keys	Primary function	Secondary function
	To turn the balance to ON or Standby	-
[→0/T←] or [Esc]	A combined zero and tare function	To escape from setup functions and modes
[Unit] /  or [Down]	Selects weighing units by cycling through a set of enabled units	To decrement or change a displayed value or scroll through options backwards
[Mode] / → or [Advance]	Enters the Modes	To advance a flashing digit by one position to the right. To go back by one step during setup functions
[Print] /  or [Back]	Instructs the balance to print data	To advance a flashing digit by one position to the left
[Cal] / or [Up]	Starts the calibration function	To increase or change a displayed value or scroll through options forward
[Setup]/  or [Enter]	Enters the Setup parameters (Supervisor Menus)	Enters a function or saves a value during setting up such as entering unit weight or check weighing limits manually

7.1 NUMERIC ENTRY METHOD

To set a value when required, use the keys as given below:

- **[Up]** and **[Down]** keys to increase or decrease the flashing digit,
- **[Advance]** and **[Back]** keys to advance or move back the digit and
- **[Enter]** key to accept the value

8.0 INPUT/OUTPUT

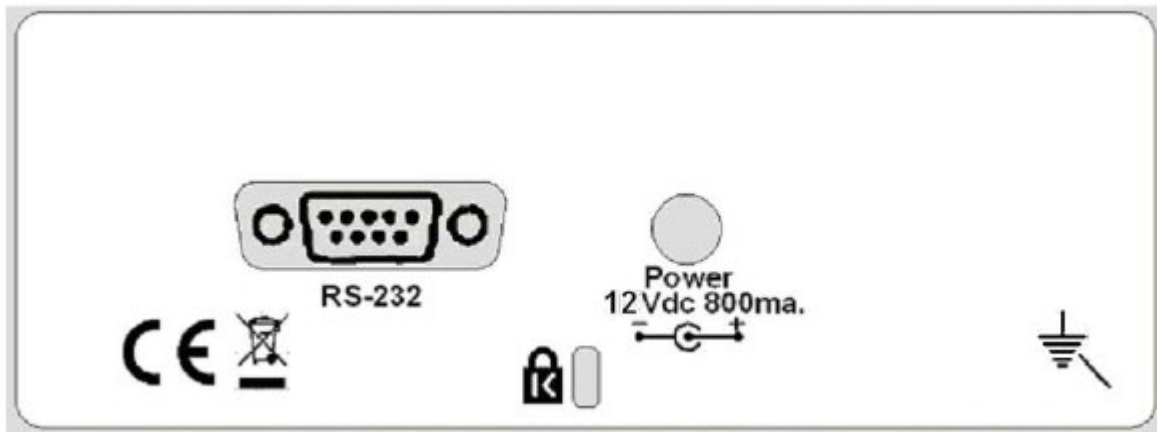

The rear panel has connectors for RS-232 serial and a power input socket. Required power input is a low-voltage external supply, 12VDC @ 800mA.



9.0 OPERATIONS

9.1 INITIALISATION



When the balance is first switched on, it will display the balance serial number (if set), software revision, model capacity and then all segments on the display will be shown. Overall the time taken is usually 5 -10 seconds.

If an operator passcode has been set, the display will show “**PASSCODE**” and the main display will show a zero. In this case you must enter the passcode to continue using the numeric entry method (see section 7.1). A different passcode may be set for a Supervisor to weigh or to have access to the selected User menus. If the passcode has not been set the balance will continue as below.



The display will show zero reading along with the zero symbol “→0←” and the weighing unit last used. If automatic time calibration is enabled the balance will calibrate 15 minutes after power up or again after the pre-set time interval.

9.2 PASSCODES

If a passcode has been set to limit access to the weighing functions of the balance the display will show “**PASSCODES**” with the main digit set to zero. Use the numeric entry method (see section 7.1) to enter the code. The display will change to show 7 digits set to zero with the rightmost digit flashing. Make sure to enter the correct passcode to continue. See the Section 13.6 for details.



9.3 WEIGHING

- Press [Tare] to zero the balance, if required “→0←” will be displayed
- Place a mass on the pan and the weight will be displayed
- If a container is used press **[Tare]** to tare the balance when the stable symbol “~” is on. “Net” will be displayed to indicate that the balance is tared.
- When the display shows zero, place the item to be weighed. Only the net weight will be displayed
- At any time the **[Units]** key can be pressed to select another unit. Use the **[Up]** or **[Down]** key to scroll through the units and select the desired unit by pressing **[Enter]**, the display will change to show the weight in the selected weighing unit. The available weighing units can be enabled or disabled by the user (see section 13.1). Only weighing units that have been enabled will be cycled through when **[Units]** is pressed.

9.3.1 Weighing Units

You can select alternative weighing units to display the weight by pressing the **[Units]** key. The available weighing units are:

	Unit	Symbol	Models	Conversion Factor 1g =	Conversion Factor 1 unit = grams
1	Grams	g	All	1	1.0
2	Milligrams	mg	not 0.01g units	1000	0.001
3	Kilograms	kg	All	0.001	1000
4	Carats	ct	All	5	0.2000
5	Pennyweights	dwt	All	0.643014865	1.555174
6	Grains	GN	All	15.43236	0.0647989
7	Troy ounces	ozt	All	0.032150747	31.103476
8	Ounces	oz	All	0.035273962	28.349523

It is possible to set the balance to display only grams. Grams will always be one of the units enabled, by default.



9.4 FUNCTIONS

When weighing, the user can access the applications that have been enabled (see section 13.2).

The following applications are available in this version (2.43 & above):

- Parts counting
- Percent weighing
- Check Weighing

The functions can be enabled or disabled using a similar method to the Units above by turning the functions to on or off.

9.4.1 Parts Counting

This allows the user to weigh a sample of parts to compute an average unit weight and then determine the number of items being weighed by dividing the net weight by the unit weight value. The result is always a whole number. The balance will have a preset number of parts to be used as a sample. These values are 10, 25, 50 or 100 items.

Steps:

- Press **[Mode]** to show parts counting, “PARTS” will be displayed
- Enter parts counting by pressing **[Enter]**
- Press the **[Up]** or **[Down]** key to select the sample size, “REF QTY”, 10, 25, 50, 100, etc., then press **[Enter]** to confirm
- When “LOAD XX Pcs” is shown place XX number of items on the pan and press **[Enter]** to compute the average piece weight. Display will indicate the total weight in the last selected unit and then show “XX Pcs” sounding a beep. A message “PARTS” will be prompted on the top of the display to indicate that the balance is in the parts counting mode
- Remove the sample and display will show “0 Pcs”.
- Place an unknown quantity on the pan. The balance will then compute the number of parts based on the average piece weight. The display will show the result in Pcs.



- To count another item press **[Mode]** and continue as before
- Checks will be made to determine that the weight of the reference parts is large enough for reasonably accurate counting (weight of each piece should be > 1d)
- To return to normal weighing, press **[Esc]**

9.4.2 Percent Weighing

Percent weighing will be done by defining a certain weight to be 100%. The weight to be used can either be entered by the user or taken from a sample

- Press **[Mode]** and then the **[Up]** or **[Down]** key to select Percent weighing, “PERCENT” will be displayed
- Press **[Enter]** to enter the function
- Display will show, “PERCENT SAMPLE”
- Press **[Enter]** to select the sample method or skip to manually enter the sample weight as given below
- When “LOAD 100 %“ is shown, add the sample
- Press **[Enter]** to set this weight to be 100%. The display will show “REF WT” and the sample weight in the last selected unit. After a while “100%” will be displayed. A message “PERCENT” will be prompted on the top of the display to indicate that the balance is in the percent weighing mode
- Remove the sample and “PERCENT 0.00%” will be displayed
- Place an unknown sample to display the percentage weight
- To set another weight as 100%, press **[Mode]** and continue as before
- To manually enter a value to be set as 100%, press **[Up]** or **[Down]** key when “PERCENT SAMPLE” is shown to select “PERCENT Ent Wt”
- Press **[Enter]**. Display will show the value in the unit, last used in the weighing mode



- Enter the weight using the numeric entry method (see section 7.1).
- Place unknown sample to display the percentage weight
- To perform percent weighing with another sample press **[Mode]** and continue as before
- To return to normal weighing, press **[Esc]**

Note: Percentage will be displayed to the maximum number of decimal places based on the resolution of the balance. To increase or decrease by one decimal place, press the **[Up]** or **[Down]** key respectively.

9.4.3 Check Weighing

During weighing of a sample the balance can be set to show if the weight is above or below an upper and a lower limit. The display will indicate when the weight is below the lower limit, between the limits or above the upper limit.

The buzzer can be set to be active when the weight is outside the limits (below the lower or above the upper) or within the limits (above the lower and below the upper limit), or turned off. If desired, only one limit needs to be set. If only one limit is set the other limit is considered to be zero (lower) or the maximum (upper).

The Check weighing is not active when the weight is less than 20d. This is the minimum weight at which the indicator bars are displayed and the buzzer sounds, if it is not set to OFF (see the next page).

Steps:

- Press **[Mode]** and then the **[Up]** or **[Down]** key to select Check Weighing. When “CHECK” is displayed press the **[Enter]** key to enter Check Weighing mode
- Press **[Up]** or **[Down]** to set the “LOW LIMIT” to “On” or “OFF”



- Press **[Enter]** to proceed. If the “LOW LIMIT” was set to “On” the display will show the current low limit in the unit last used in the weighing mode. You may change the limit using the numeric entry method (see section 7.1).
- Press **[Enter]** to proceed
- If the “LOW LIMIT” was set to “OFF” or the setting of the low limit is complete, then the display will change to “HIGH LIMIT”. Use **[Up]** and **[Down]** to set the “HIGH LIMIT” to “On” or “OFF”
- Press **[Enter]** to proceed
- If the “HIGH LIMIT” was set to “On”, the display will show the current high limit in the last selected unit which can be changed in the same way as in case of “LOW LIMIT”
- Press **[Enter]** to proceed
- Next the beeper setting is displayed. Press **[Up]** or **[Down]** to scroll through the options-

“BUZZER OFF”	(Beeper set to off at all times)
“BUZZER In”	(Beeper will sound when the weight on the pan is stable and within the limit)
“BUZZER Out”	(Beeper will sound when the weight on the pan is stable and outside the set limits)
- Confirm the beeper setting by pressing **[Enter]**
- When a weight is placed on the pan now, the display will indicate whether the weight is below the LOW LIMIT between the LOW and HIGH LIMITS or higher than the HIGH LIMIT.
- To perform check weighing with another sample press **[Mode]** and continue as before
- To return to normal weighing, press **[Enter]**



10.0 CALIBRATION

The balances are calibrated using an external mass.

- Press the **[Cal]** key to start calibration.
- Pressing **[Esc]** will abort the calibration at any time
- Press the **[Cal]** key
- The display will show the balance setting a new Zero condition by showing “LOAD 0”. Make sure the pan is empty then press the **[Enter]** key to continue
- The display will show the busy symbol and then will ask for the value of the calibration mass to be entered sounding a beep and displaying the default calibration mass. For example, for the 410g model the display will be “CAL MASS 200,000 g” where 200g is the default calibration mass. Using the numeric entry method, the user may alter the displayed value to any value ranging from one-third to full capacity of the balance. For example, “CAL MASS 300,000 g”. Press **[Enter]** to continue
- The balance will then show the value of the calibration mass selected sounding a beep, i.e., “LOAD 300,000 g”
- Place the selected mass on the balance. Press **[Enter]** to continue
- The display will show the busy symbol and after calibration is complete it will display “UNLOAD” sounding a beep. Remove the weight. Another beep will be heard confirming the unloading action. The balance will then return to normal weighing.

The balance will have the ability to ask for calibration when the following conditions occur. This feature can be enabled or disabled by the user (see section 13.5). The conditions are:

1. Internal temperature change greater than a preset amount, typically 2°C.
2. Time since last calibration exceeds a preset time, typically 4 hours or 15 minutes after power is applied.



The user will know a calibration is asked for from flashing of the “CAL” symbol on the display. The display will show a 5 second countdown when calibration will start. If the user presses the [Esc] key the calibration will be delayed by one minute to allow for a process in progress to be finished. As soon as the balance is calibrated the symbol will be turned off.

Suggested calibration weight:

MPB410	200g
--------	------

Calibration Errors

Occasionally during calibration an error will be detected. These errors can be caused by unstable readings, improper weights being used, large shifts of zero from the factory settings, etc. When an error is found a message will be shown and the calibration must be done again.

11.0 RS-232 INTERFACE

The balances have the ability to send data to the serial interface.

The weighing data can be sent over the interface by using a PC either automatically or when the user presses the [Print] key.

The user has control over what data to be printed.

The following shows a description of the RS-232 interface.

HARDWARE

The RS-232 interface is a simple 3 wire connection. The input and output connections are:

- Connector:**
- 9 pin D-sub miniature socket
 - Pin 2 input to balance RXD
 - Pin 3 output from balance TXD
 - Pin 5 Signal ground GND
- Handshaking is not applied.

Baud rate: 4800, 9600, 19200, 38200



Parity: NONE (=8N1), EVEN (=7E1) or ODD (=7 O 1)

All lines are terminated with carriage return and line feed (<CR><LF>).

In continuous output mode, or if single-line output on demand is selected, the serial output format will be a single line in the form “1234.567 g<CR><LF>”.

The format of the single-line output will change depending on the mode in which the balance is operating, as described below.

If output on demand is selected, the user may optionally configure the serial output as a choice of 3 styles of form, either in a default format or in one of two custom formats. Each of the custom formats can be configured to output up to 15 lines of data. The data types that can be printed are:

NAME	TEXT PRINTED
ID number	ID no.: xxxxxxxxxxxx
Serial number	Serial no. xxxxxxxxxxxx
Date	DATE dd/mm/yyyy
Time	TIME hh:mm:ss
Net weight	Net: xxx.xxx g
Gross weight	Gross: xxx.xxx g
Tare weight	Tare: xxx.xxx g
Unit weight	Unit wt: xxx.xxx g
Count	Count: xxxx pcs
Reference weight	Ref. wt: xxx.xxx g
Percent	Percent: xx.xxx %
A blank line printed	<CR><LF> only.

Any of these can be printed on any of the 15 lines available. A blank line can also be printed. Not all items need to be used and any one can be used more than once (see section 13.3).

The data for each form will be preceded by a start-of-header <SOH> character (01) and terminated with an end-of-transmission <EOT> character (04). These characters will be ignored by a serial printer but will allow a computer program which reads the data to distinguish between this block report format and the single-line output format described above.



STANDARD FORMAT

The balance will print the following data as the standard form. The standard form cannot be changed. The format of forms #1 and #2 will be the same as the standard until modified by the user.

Line 1	Date
Line 2	Time
Line 3	Blank line
Line 4	ID number
Line 5	Blank line
Line 6	Result
Line 7	Blank line
Line 8	Blank line

This will result in a printout that looks like:

***NOTE:** The format of the results line will change depending on the mode in which the balance is operating, e.g.

Normal weighing: "123.456 g"

Parts Counting: "1234 pcs"

Percent weighing "12.345 %"

Date: 23/09/04

Time: 15:45:27

ID No: 123456

Net: 123.456 g

INPUT COMMANDS USING REMOTE KEYS

The balance can be controlled with the following commands sent using remote keys such as from a PC. The commands must be sent in upper case letters, i.e. "KT" not "kt". Press



the Enter key of the PC after each command (the action of Carriage Return is denoted as <CR> as shown below).

Basic Input Commands:

!KT<CR>	Tares the balance to display the net weight. This is the same as pressing the [Zero / Tare] key when the balance is in the normal weighing mode.
!KS<CR>	Enters the Setup section. This is the same as pressing the [Setup] key when the balance is in the normal weighing mode. Once entered the Setup section, the balance can be controlled remotely using the Input Commands (as mentioned in this table) which will perform the same key functions as described in section 13.0.
!KP<CR>	Transmits data over RS-232 interface. This is the same as pressing the [Print] key when the balance is in the normal weighing mode.
!KM<CR>	Enters the Modes section. This is the same as pressing the [Mode] key when the balance is in the normal weighing mode.
!KC<CR>	Enters the Calibration section. This is the same as pressing the [Cal] key when the balance is in the normal weighing mode.
!KU<CR>	Enters the Unit selection section. This is the same as pressing the [Units] key when the balance is in the normal weighing mode.

Invalid Input Command:

If an invalid command is received, then the command is returned as follows:

Invalid Command	Message returned	Remarks
!NT<CR>	!EU<CR>	Command character is not 'K'
!KK<CR>	!EK<CR>	Key character is not 'T', 'S', 'P', 'M', 'C' or 'U'
!KT-<CR>	!EF<CR>	Command format error, <CR> is not the fourth character
KT<CR> or !KT -	No reply	Either '!' or <CR> is missing in the command string



12.0 ERROR CHECKING

During weighing the balance is constantly checking to see if the balance is operating within the limited parameters. The errors likely to occur are:

- A/D counts below lowest allowed value
- A/D counts above highest allowed value
- A/D not operating
- Maximum capacity exceeded

Other errors may be detected during special functions or operations. These will be described in the section that applies.

Error messages and the reasons are:

Concerning A/D counts	
ERROR ADc UL	A/D counts below a limit
ERROR ADc OL	A/D counts above a preset limit
Concerning calibration	
ERROR StAb	Calibration could not be completed because the results were not stable
ERROR LO or ERROR HI	Calibration constant not within 20% of old calibration constant
Concerning weighing	
ERROR LO	Weight display is below zero by >4%max
ERROR LOAd	Weight is above maximum plus 90d



13.0 SUPERVISOR MENUS

Pressing the [Setup] key while in normal weighing gives access to the menus.

- **When [Setup] is pressed and passcodes are not enabled the display will show the Supervisor menus.** If passcodes are enabled, the balance will ask for it by displaying “PASSCODE 0”
- If a wrong code is entered an “ERROR CODE” message will flash and the balance will return to weighing mode
- If the passcode has been enabled and entered, the balance will allow the operator to access the Supervisor’s menus by which the user can enable/disable weighing units or modes, set balance parameters for the conditions, set time and date, set parameters for the RS-232 interface, calibration parameters and security parameters
- The display will show the first menu item “UNITS”. The **[Up]** and **[Down]** keys will cycle through the main menu item, pressing the **[Enter]** key will enter the sub-menu or options can be set. Press **[Mode]** to come out of a sub-menu or **[Esc]** to return to normal weighing

13.1 ENABLE WEIGHING UNITS

- When “UNITS” is displayed, press **[Enter]**. The display will show the symbol for the first unit, e.g. carats, ct, together with its enable state “OFF” or “On”. The user can then enable or disable the carats unit by using **[Up]** or **[Down]**. Pressing **[Enter]** will confirm the setting and will advance to the next weighing unit. Repeat for each weighing unit in turn. Gram is always enabled
- Press **[Mode]** to advance to setting of the next menu or press **[Esc]** to return to normal weighing

13.2 ENABLE WEIGHING MODES

Same steps are followed to enable or disable the weighing modes.

- Press **[Enter]** when “MODES” is displayed. The display will show the first mode i.e., Parts Counting (“PARTS”) together with its enabled state “OFF” or “On”. The user can enable or disable the parts counting mode by using **[Up]** or **[Down]**. Pressing



[Enter] will confirm the setting and will advance to the next weighing mode. Repeat for each mode in turn

- Press **[Mode]** to advance to setting of the next menu or press **[Esc]** to return to normal weighing

13.3 ENABLE SERIAL INTERFACE PARAMETERS

The parameters affecting the serial setup are set in a similar manner to the other parameters.

Press **[Enter]** when “SERIAL” is displayed to enter the sub-menu.

The parameters that can be set are:

ENABLE	The serial port can be set to On or OFF
BAUD RATE	Set the Baud Rate to 4800, 9600, 19200 or 38400, the default rate being 4800
PARITY	Set the Parity to NONE, EVEN or ODD
STABLE	To print when stable (On) or regardless of stability (OFF)
CONTINUOUS	Set the RS-232 to send data continuously to On or OFF
PERIODIC	Set the RS-232 to send data periodically (set in seconds) to On or OFF. If On is selected, the value can be changed between 1 and 999 seconds, using [Up] and [Down]
FORMAT	To send data as a single line of data, using the standard format or using a customer designed format (FORM 1 or FORM 2).



Format of custom forms #1 and #2

If FORM1 or FORM2 is selected, it can be changed by the user using a selection of available data. By default the 2 forms are the same as the standard form unless changed by the user as below.

When FORM 1 or FORM 2 is selected the user can set the information to be printed on each line of the form. Pressing the [Up] or [Down] keys will cycle through the options available. The options are:	
INST ID	Instrument ID number
SER No	Serial Number
TIME	Time
DATE	Date
NET	Net Weight (Gross weight – Tare Weight)
GROSS	Gross Weight
TARE	Tare Weight
UNIT	Unit weight in parts counting mode
COUNT	Number of items in parts counting mode
REF	100% weight in percent weighing mode
PERCENT	Percentage of reference weight in percent weighing
Cr Lf	Inserts a blank line
END	Signifies the end of the report When END is entered the display returns to the RS-232 Sub-menu

Enter the data to be printed on the first line by pressing the **[Up]** or **[Down]** key to cycle through the options. If the current information is OK then press the **[Setup]/Enter** key to move to the next line.

e.g. "LINE No1" "DATE" - prints date

Select a code for one of the preset data formats as detailed above.

The next line shows: "LINE NO 2" "TIME" - prints time Only one item can be entered per line.

Continue until the formatting of the form is complete. There are 15 lines of possible data. After the 15th line has been set or "END" has been selected, the balance will return to the RS-232 Sub-menu.



Press **[Mode]** to advance to setting of the next menu or press **[Esc]** to return to normal weighing.

13.4 SETUP PARAMETERS

The user parameters that control the balance are shown under the SETUP. When “SETUP” is displayed, press the **[Setup]/Enter** key. The options for each parameter can be scrolled through by using the **[Up]** or **[Down]** key.

LANGUAGE	English French German Spanish
TIME	Set Time using the numeric entry method (see section 7.1)
DATE DATE FORM EUROPE (dd/mm/yy) USA (mm/dd/yy)	Set Date using the numeric entry method (see section 7.1)
INST ID	Enter a user number to identify this balance
BUZZER	On= Enable OFF= Disable
BACKLIGHT	On OFF AUTO (default)
POWER DOWN	Set the time after which the unit will go into Stand-by power settings, On=Enable, OFF=Disable, If set to On- the options are 1 to 9 minutes
FILTER	Set a value for the amount of filtering to be done ranging from 1 to 10. A larger number means more filtering and a slower response.
STABILITY	Set a value to be used to determine balance stability, set a value of 1, 2, 5 or 10d. A larger number corresponds to a larger stable zone. Default is 5
AUTO ZERO	Can be set to On or OFF to enable the auto-zero function. If set to On- select from 1, 2 or 5d

The sub-menu is entered by pressing **[Enter]** –

- Use the **[Up]** and **[Down]** keys to increase or decrease the value for setting. Press **[Enter]** to accept the setting and advance to the next item in the menu



- Press **[Mode]** to advance to setting of the next menu or **[Esc]** to return to normal weighing

13.5 CALIBRATION SETUP

This menu allows the user to set the calibration parameters.

- Press **[Enter]** when “CAL SETUP” is displayed to select the calibration parameters
- The options for each parameter can be scrolled through by using the **[Up]** or **[Down]** key

ENABLE	NO =operator calibration is disabled YES=operator calibration is enabled
CAL REPORT	On = Enabled. Prints out Calibration report after successful calibration OFF = Disabled
TIME CAL	On = Enabled. Select time from 1 to 24 hours. Default setting is 4 hours OFF = Disabled
TEMP CAL	On = Enabled. If set to On, set the temperature variation from 0.2 to 4°C OFF = Disabled

- Press **[Mode]** to advance to setting of the next menu which is “PASSCODES” or **[Esc]** to return to normal weighing.



13.6 PASSCODES

To enable the security features in this balance it is necessary to set passcodes. There are 2 passcodes called Operator Passcode and Supervisor Passcode. The Operator Passcode allows an authorised user to operate the basic weighing functions of the balance but will not allow access to the Supervisor Menus if the Supervisor Passcode has been set.

To change or disable a Passcode it will be necessary to enter the current passcode.

Press **[Enter]** when “PASSCODES” is displayed to enter this section.

OPERATOR	Enter the current passcode (OLD) first then enter a new passcode if desired. A passcode set to zero will disable the security feature and allow unlimited access.
SUPERVISOR	First enter the current passcode (OLD) and then enter a new passcode if desired. A passcode set to zero will disable the security feature and allow unlimited access.

13.6.1 Forgotten Passcodes

Keep a record of the passcode to ensure you can access this section again. If however you have forgotten your passcode you can still gain access by entering a universal code.

If you have forgotten the current passcode a code of “15” will always allow you to enter the Supervisor area.

Using the Supervisor menus go to the PASSCODE section and reset the operator or Supervisor passcode using the “15” code as the old number when asked.



14.0 SAFETY AND MAINTENANCE

CAUTION

Use the AC adapter designed by the manufacturer for the balance. Other adapters may cause damage to the balance.

Avoid overloading or dropping material onto the platform which could damage the balance.

Do not spill liquids on the balance as it is not water-resistant. Liquids may damage the case and if it gets inside the balance it may cause damage to the electronics.

Material that has a static electric charge could influence the weighing. Discharge the static electricity of the samples, if possible. Another solution to the problem is to wipe both sides of the pan and the top of the case with an anti-static agent.

15.0 TROUBLE-SHOOTING

Service of this Precision Balance will generally be necessary when the balance does not perform as expected. The balances are not user serviceable. For Service Information contact your supplier.

Problems usually fall into one of the following categories:

User Problems:

The user is asking the balance for something it cannot do or is confused by the modes and functions of a balance. It is also possible the user has set a parameter that has affected the balance operation. Resetting the parameter to a normal value will restore operation.

Mechanical Problems:

These are the rarest of the problems affecting balances. If an electronic problem is suspected make sure the mechanical problems that can cause similar symptoms have been eliminated before attempting electronic repairs. With the exception of cables most electronic repairs are solved by PCB replacement. The Electronics modules within the balance are not serviceable. In case of any electronics component failure, contact your supplier.



Electronic Problems:

These are the rarest of the problems affecting balances. If an electronic problem is suspected make sure the mechanical problems that can cause similar symptoms have been eliminated before attempting electronic repairs. With the exception of cables most electronic repairs are solved by board replacement.

The table that follows is a guide of common problems and their solutions. Note that many problems may have multiple solutions and there may be problems found that are not listed in the table. For Service Information, contact your supplier.

BALANCE DOES NOT FUNCTION		
Problems	Possible causes	Suggestions
The balance is dead when power is applied	Power supply failure	Check adapter is working Check adapter is correct for the balance Normal adapter is 15VDC, 800mA. *Power supply circuit board failure *Short circuit on any circuit board
The display does not turn on	Power is getting to balance, display is not working	*Display cables may be faulty *Display module failure
The display stays on the initial test screen when power is applied	Unstable balance Balance not working correct Power supply	*Check if balance is stable by using service menu and view A/D values Put draught shield over pan Check power supplies



BALANCE WORKS BUT IS NOT STABLE		
<p>Balance is unstable by a few divisions</p>	<p>Noise or vibration from environment Friction in mechanics</p>	<p>Check whether the temperature is stable.</p> <p>Check the balance is positioned correctly to avoid vibration, wind or air movement, it is on a solid table, It is not near sources of heat or cool air,</p> <p>Check balance with weights if problem occurs when sample is used. Static electricity on the samples can cause drifting and instability.</p> <p>Check the area around the weighing pan for hair, dust, obstructions under the pan.</p> <p>*A complete inspection of the mechanics to look for sources of friction may be needed.</p>
<p>Balance is very unstable and does not weigh correctly</p>	<p>Mechanical problems Balance programming Electronic problems</p>	<p>Check whether the temperature is changing or there is a draft.</p> <p>*A complete inspection of the mechanics to look for sources of friction.</p> <p>*Verify the A/D is also unstable. If the A/D is OK then suspect the programming of the balance. Reset parameters, check temperature compensation, and redo the calibration.</p> <p>Some electronic problems can also cause this. But all mechanical problems must be resolved first.</p>



BALANCE IS NOT ACCURATE		
<p>You must have accurate and trusted weights to test a balance. If you suspect that the balance is not accurate then you must know your weights are accurate. A balance calibrated using a bag of flour is not accurate even if it works OK otherwise.</p>		
Balance is not accurate	Repeatability	Verify the balance shows the same value when the same mass is placed on the center of the pan for a few tests.
	Eccentric loading	Verify the balance shows the same reading (within a tolerance depending upon the model) when a mass is placed at positions around the pan.
	Linearity	Verify the balance is acceptable throughout the weighing range. The balance must give acceptable readings from low weights up to the capacity.
Poor Repeatability	Usually a mechanical problem.	Inspect the area around the pan for hair, dust or other obstructions, *Inspection of the mechanics may be needed for any possible problems.
Poor Eccentric loading	A mechanical problem	Inspect the area around the pan for hair, dust or other obstructions, *Inspection of the mechanics may be needed for any possible problems. *Readjusting of the Eccentric loading is recommended.



Poor Linearity	Usually a mechanical problem.	<p>Re-check repeatability</p> <ul style="list-style-type: none"> *Inspection of the flexures for damage or loose hardware may be required *Use the Linearity Function in the service menu to reset linearity *A problem in the analogue circuit board or power supplies can cause poor linearity. Make sure all mechanical problems have been eliminated first
OTHER PROBLEMS		
Cannot calibrate	<p>Zero shifted more than allowed</p> <p>Calibration timeout</p>	<ul style="list-style-type: none"> *Check all flexures for damage *Reset dealer calibration *Verify linearity and repeatability *The balance may be unstable. Verify stability as above. Try using a more aggressive filter
RS-232 not working	Doesn't print	<p>Check parameters match the device connected</p> <p>Verify cable is correct</p> <ul style="list-style-type: none"> *RS-232 circuits damaged
Display dark, keys beep	<p>Display contrast poor</p> <p>Cable damaged</p> <p>LCDs on the display are faulty or damaged</p>	<ul style="list-style-type: none"> *Check the cables to the display *Replace display-it may be damaged

16.0 BALANCE MENU STRUCTURE

MENU STRUCTURE

WEIGHING

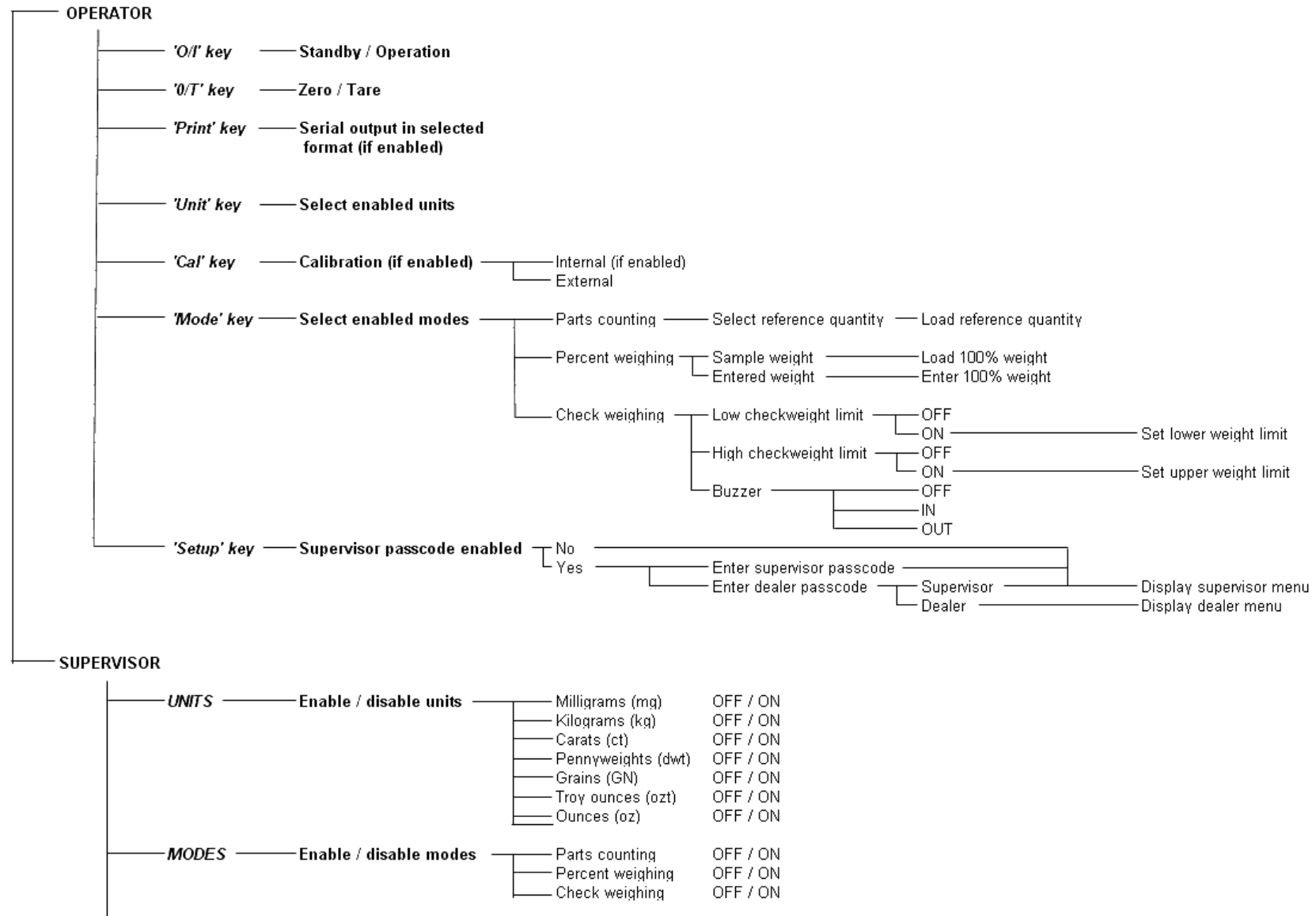

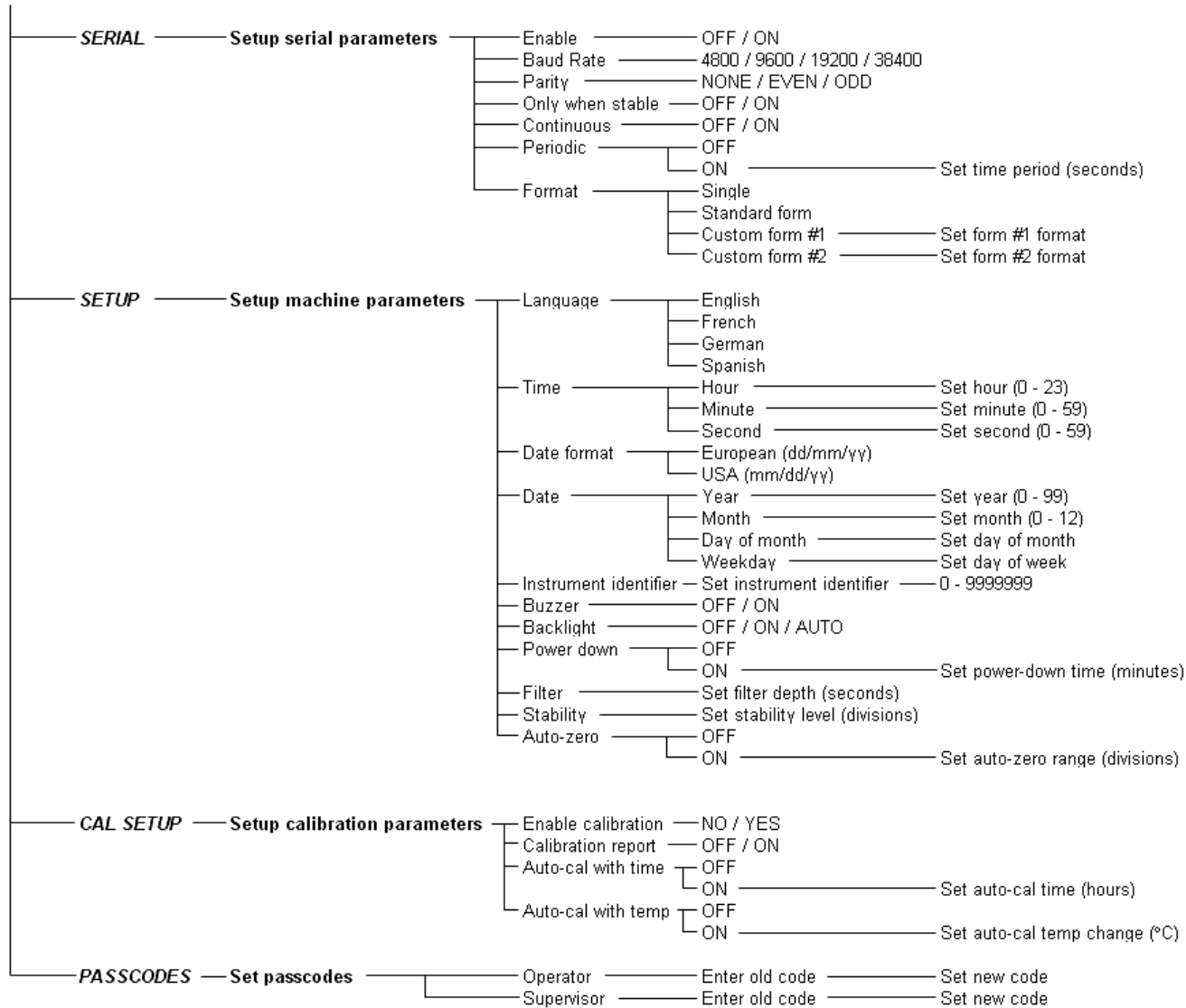



Manufacturer's Declaration of Conformity

This product has been manufactured in accordance with the harmonised European standards, following the provisions of the below stated directives:

Electro Magnetic Compatibility Directive 2004/108/EC

Low Voltage Directive 2006/95/EC

FCC COMPLIANCE

This equipment has been tested and found to comply with the limits for a Class A digital device, pursuant to Part 15 of the FCC Rules. These limits are designed to provide reasonable protection against harmful interference when the equipment is operated in a commercial environment. The equipment generates, uses, and can radiate radio frequency energy and, if not installed and used in accordance with the instruction manual, may cause harmful interference to radio communications. Operation of this equipment in a residential area is likely to cause harmful interference in which case the user will be required to correct the interference at his own expense. Shielded interconnect cables must be employed with this equipment to insure compliance with the pertinent RF emission limits governing this device. Changes or modifications not expressly approved by the manufacturer could void the user's authority to operate the equipment.

WEEE COMPLIANCE



Any Electrical or Electronic Equipment (EEE) component or assembly of parts intended to be incorporated into EEE devices as defined by European Directive 2002/95/EEC must be recycled or disposed using techniques that do not introduce hazardous substances harmful to our health or the environment as listed in Directive 2002/95/EC or amending legislation. Battery disposal in landfill sites is more regulated since July 2002 by regulation 9 of the Landfill (England and Wales) Regulations 2002 and Hazardous Waste Regulations 2005. Battery recycling has become topical and the Waste Electrical and Electronic Equipment (WEEE) Regulations are set to impose targets for recycling.



Change log

Date of change	Change	Version
07-11-2019	New manual	001